

POWER MONITORS

ENERIUM RANGE



Minimize your energy consumption and optimize your installation



From 0.2s critical electricity metering to the collection of metering data on all utilities

Electrical feeder analysis: alarms, recordings, harmonics, EN50160

French measurement expert and manufacturer with more than 25 years' experience

Measure up



TERTIARY AND INDUSTRY

Launch an energy-saving operation on the basis of the consumption data measured or collected by the ENERIUM power monitors

Without disconnection

Quick and easy installation and implementation of the ENERIUM power monitors used with our non-intrusive sensors



Real-time monitoring of the behaviour of your machines or production lines

By means of a clear display of your consumption data and the electrical behaviour of your installations



Energy monitoring

A turnkey solution with a direct connection between the ENERIUM power monitors and our E.ONLINE 3 energy supervision software



ISO 50001

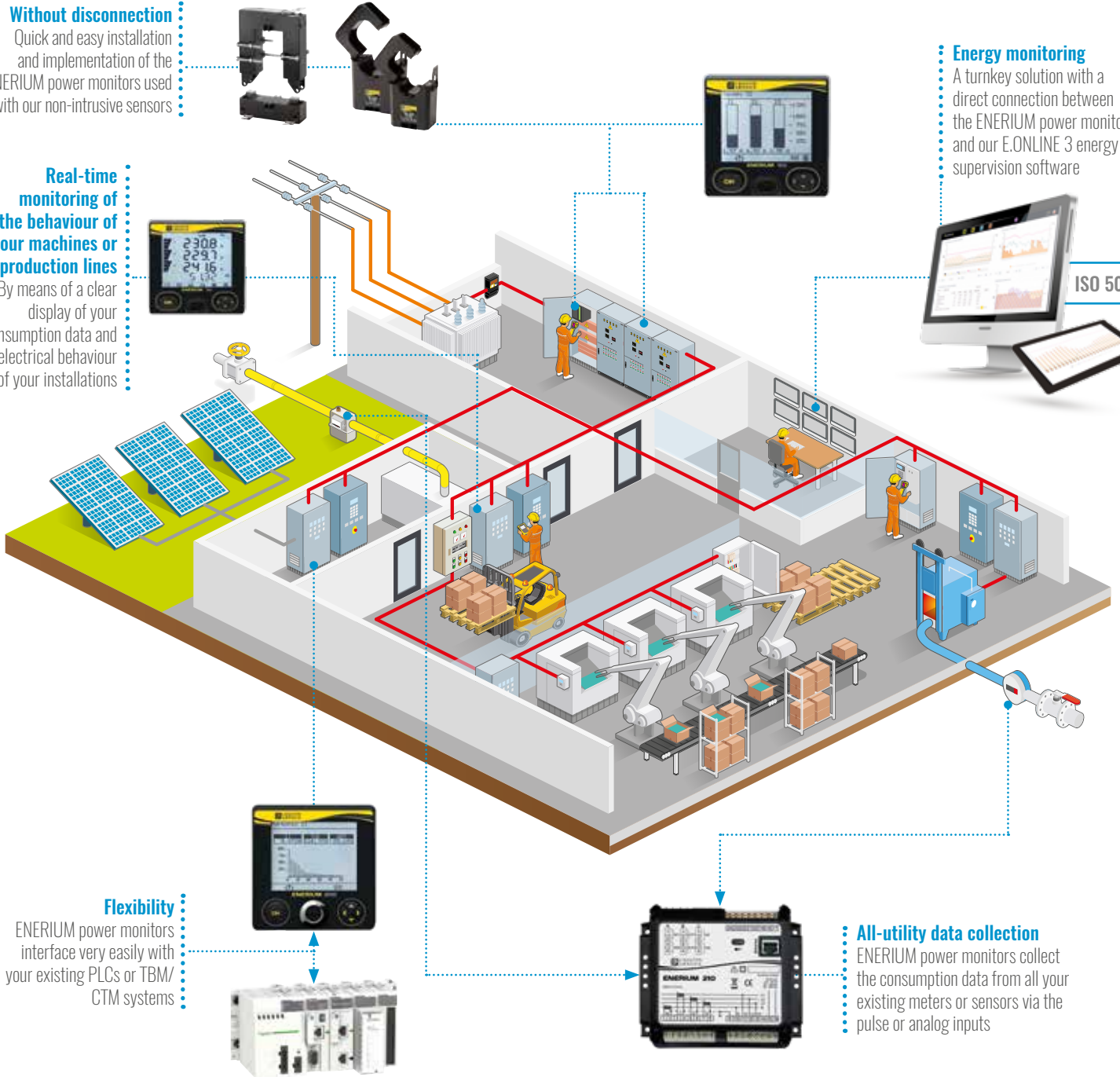

Flexibility

ENERIUM power monitors interface very easily with your existing PLCs or TBM/CTM systems



All-utility data collection

ENERIUM power monitors collect the consumption data from all your existing meters or sensors via the pulse or analog inputs



1989

Pioneer of the design and manufacture of power monitors in France

IEC

Guarantee of the best accuracy according to the acknowledged international reference standards: IEC 61557-12, IEC 62053-21/22, etc.

POWER GENERATION, TRANSMISSION AND DISTRIBUTION

Control and monitor all your electrical networks with the ENERIUM power monitors' analysis functions

Toward the digital substation

ENERIUM can be upgraded at any time to use IEC 61850 communication via the ELINK 61850 gateway



Performance

Measure and meter HV/MV electrical feeders with very high accuracy (0.2s)

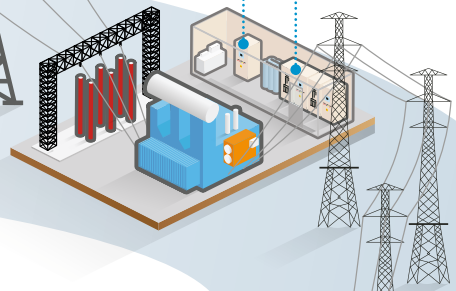
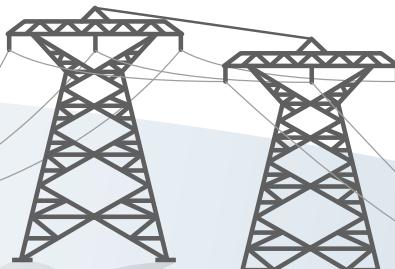
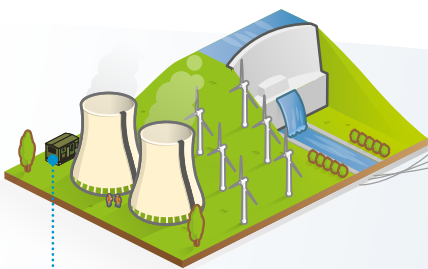

Advanced functions

From measurement of harmonic disturbances to detection of voltage events (dips, outages, etc.)

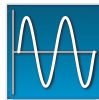

Flexibility

The analog outputs can be used to transmit the electrical quantities measured (P, V, I, F, etc.) to PLCs, panel meters, etc.

Interaction with the environment

ENERIUM detects and stores the status changes and triggers the alarm outputs in the event of overruns

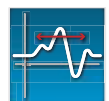

6 models to cover all the applications, from simple consumption metering to the most critical measurements



Extensive, customizable communication functions

FUNCTIONS

Real-time display

of the instantaneous, average, min., max. values, etc.

Time/date-stamped recording

of the min and max. values, etc.

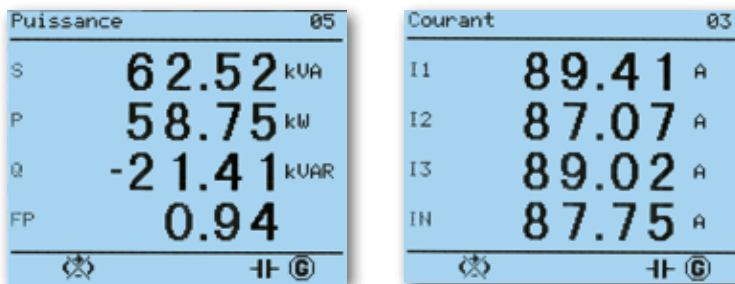

Alarms

- 16 programmable alarms on instantaneous values, averages, min., max., analog and on-off inputs (circuit-breaker status, for example)
- Recording of the last 64 events (values reached, dates, times, duration)
- Flashing of the display in the event of an alarm

Alarmes

Numéro	Statut	Relais
1	-	-
2	-	-
3	-	-
4	-	-
5	-	-
6	-	-
7	-	-
8	-	-
9	-	-
10	-	-
11	-	-
12	-	-
13	-	-
14	-	-
15	-	-
16	-	-



Graphics for easier data analysis

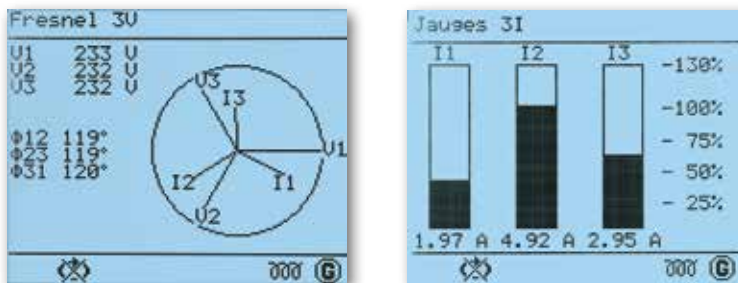

- Connection checks, measurement of the unbalance and display of the phase shift

- Load factor monitoring (display of V, U, I and P)



Indication of connection errors

during start-up



Simple, intuitive, customizable navigation for



Keys for **confirmation** and **navigation** via drop-down menus



quick access to the required information.

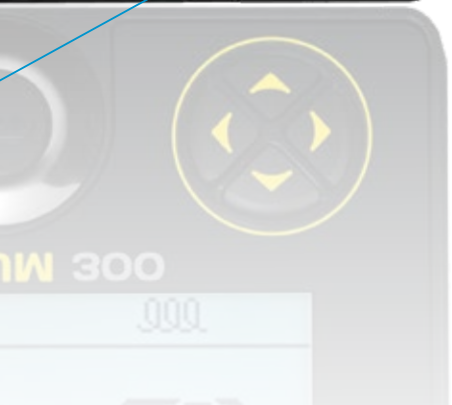

Local access via
USB cable/
optical head dedicated to :
- programming
- data reading
- software upgrades



Recording

- Indexes, consumption curves⁽¹⁾ (electricity, water, gas, etc.) and temperature curves⁽¹⁾
- Critical parameters with triggering according to 3 different modes (date, alarm, on-off input) and possibility of pre/post-trigger⁽²⁾

(1) Load curves. (2) Trend curves



Preventive maintenance

- Installation operating time
- Duration of use of the equipment monitored



Quick programming

- CT ratios and communication parameters configurable on front panel and remotely
- Protection possible by password



Customizable screens

- Free organization of the information on 3 screens with 4 display lines



Harmonic analysis

- Measurement of THD per phase on U, I and In
- Spectral analysis up to 50th order per phase on V, U, I and In

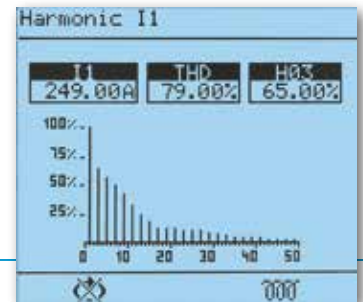

Power quality



- Graphs for statistical analysis as per EN50160

- Log of the last 1,024 events (dips, outages, overvoltages, overcurrents)
Waveform capture (V-U-I-In)

CHOOSE YOUR POWER MONITOR



ENERIUM 30



ENERIUM 50



ENERIUM 150



ENERIUM 100



ENERIUM 200



ENERIUM 300

ELECTRICAL POWER

MULTI-ENERGY

POWER QUALITY

**



111/211/221

321

332

232

332

333

Functional specifications

Accuracy class (as per IEC 61557-12)	1	0,5	0,5	0,5	0,5 ou 0,2	0,2
Format	96 x 96 mm	96 x 96 mm	96 x 96 mm	144 x 144 mm	144 x 144 mm	144 x 144 mm
Backlit LCD screen	•	•	•	•	•	•
Version without display	-	-	-	Enerium 110	Enerium 210	Enerium 310
Mounting	Flush-mounting - DIN Rail* Plate-mounting*	Flush-mounting - DIN Rail* Plate-mounting*	Flush-mounting - DIN Rail* Plate-mounting*	Flush-mounting - DIN Rail* Plate-mounting* (Enerium 110)	Flush-mounting - DIN Rail* Plate-mounting* (Enerium 210)	Flush-mounting - DIN Rail* Plate-mounting* (Enerium 310)
Harmonics						
Max. order	-	25	50	25	50	50
Recording function						
8 load curves	-	•	•	-	•	•
4 trend curves	-	-	•	•	•	1
Alarms						
Number of alarms	2	16	16	16	16	16
Time/date-stamped recorded events	-	64	64	64	64	64
Power quality functions						
Power quality as per EN50160	-	-	-	-	-	•
Waveform capture on V, U, I, In	-	-	-	-	-	16
Storage of the last 1,024 time/date-stamped events (dips, outages, overvoltages)	-	-	-	-	-	•
Inputs / outputs						
Max. number of inputs/outputs	1	2	2	8	8	8
Inputs (option)						
On-off (pulse or alarm mode)	-	0,1 ou 2	0,1 ou 2	0, 2, 4, 6 or 8	0, 2, 4, 6 or 8	0, 2, 4, 6 or 8
Analog	-	-	-	-	-	-
Outputs (option)						
On-off (pulse or alarm mode)	1	0,1 or 2	0,1 or 2	0, 2, 4, 6, or 8	0, 2, 4, 6, or 8	0, 2, 4, 6, or 8
Analog	0	0 or 2	0 or 2	0,2 or 4	0,2 or 4	0,2 or 4
Graphs						
Fresnel	-	-	•	•	•	•
Gauges	•	-	•	-	-	-
Histograms of harmonic orders	-	-	•	-	•	•
Communication interface						
Optical / USB	-	Front	Front	Front or rear	Front or rear	Front or rear
Ethernet or RS485	RS485	•	•	•	•	•
Metrological LED	-	-	-	•	•	•
Other functions						
Programming on front panel	•	•	•	•	•	•
Programming by software	-	•	•	•	•	•

* With mounting kit

Advantages



An optical/USB head dedicated to:

- Programming
- Data reading
- Software upgrades

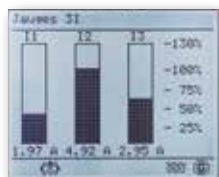

Display of graphs
(Fresnel, gauges, harmonics)



Version without display for mounting
on DIN rail or plate (ENERIUM
110/210/310)



Up to 8 on-off or analog
inputs/outputs

MAIN SPECIFICATIONS

Dimensions

ENERIUM 30/50/150

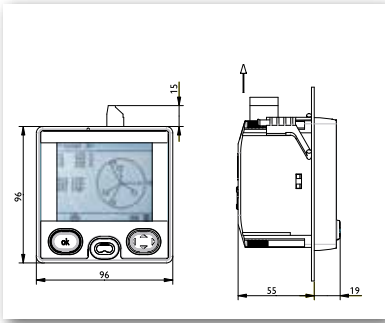

ENERIUM 100/200/300

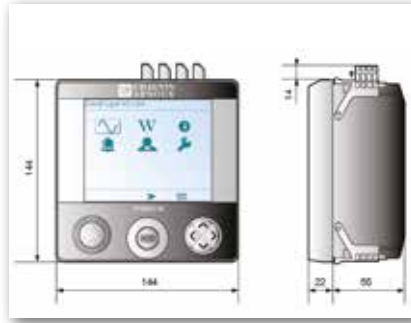

ENERIUM 110/210/310

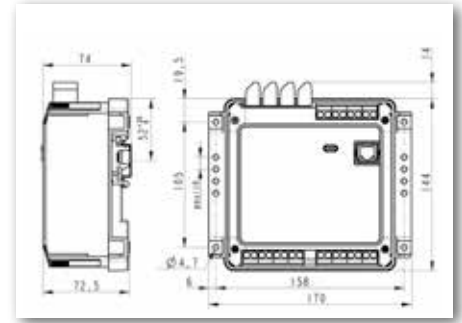

RELATED SOFTWARE

Configuration, diagnostic, installation and display software dedicated to the ENERIUM range of power monitors

Functions	Description	Status	Configuration	Diagnostic	Display	Graphs
E.View						
E.View+						

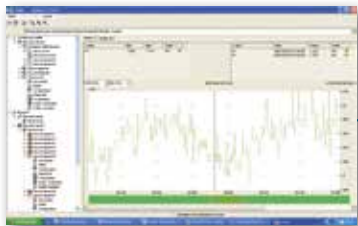

- **Energy management**
- Display of load curves
- Comparison of energy consumption and temperature curves



- **Phase shift measurement**
- Commissioning facilitated by simple visual check
- Measurement of the phase angles and unbalances (V, U, I)



- **Programming and management**
- Configure your power monitors remotely
- Keep your network architecture

E.ONLINE 3, comprehensive software for supervision, analysis and power monitoring

- Centralizes and consolidates all the data from the power monitors
- System which provides relevant data for the energy review in the context of ISO 50001 certification
- Comparison of energy consumption and temperature curves



ADDITIONAL INFO



For your IEC 61850 networks, don't forget to use ENERIUM with the ELINK communication gateway

- Modernizes the protocol for your measuring equipment without calling into question your choice of power monitors
- Up to 10 power monitors
- Certified DNV.GL



Mounting accessories

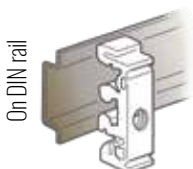

On DIN rail

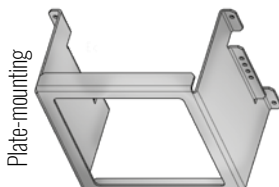

Plate-mounting

Standard products

Model	Frequency	Accuracy class	Power supply	Communication	On-off input	On-off outputs	Analog outputs	Reference
ENERIUM 30	50 / 60 HZ	1	230 to 400 Vac/Vdc	RS485	0	0	0	P01330823
ENERIUM 30	50 / 60 HZ	1	230 to 400 Vac/Vdc	RS485	0	1	0	P01330824
ENERIUM 50	50 / 60 HZ	0.5 s	80 to 265 Vac / 110 to 375 Vdc	RS485	0	0	0	P01330805
ENERIUM 50	50 / 60 HZ	0.5 s	80 to 265 Vac / 110 to 375 Vdc	Ethernet	0	0	0	P01330806
ENERIUM 50	50 / 60 HZ	0.5 s	80 to 265 Vac / 110 to 375 Vdc	RS485	1	1	0	P01330807
ENERIUM 50	50 / 60 HZ	0.5 s	80 to 265 Vac / 110 to 375 Vdc	Ethernet	1	1	0	P01330808
ENERIUM 150	50 / 60 HZ	0.5 s	80 to 265 Vac / 110 to 375 Vdc	RS485	0	0	0	P01330809
ENERIUM 150	50 / 60 HZ	0.5 s	80 to 265 Vac / 110 to 375 Vdc	Ethernet	0	0	0	P01330810
ENERIUM 150	50 / 60 HZ	0.5 s	80 to 265 Vac / 110 to 375 Vdc	RS485	0	2	0	P01330811
ENERIUM 150	50 / 60 HZ	0.5 s	80 to 265 Vac / 110 to 375 Vdc	Ethernet	0	2	0	P01330812
ENERIUM 100	50 / 60 HZ	0.5 s	80 to 265 Vac / 110 to 375 Vdc	RS485	0	0	0	P01330831
ENERIUM 100	50 / 60 HZ	0.5 s	80 to 265 Vac / 110 to 375 Vdc	RS485	2	2	0	P01330832
ENERIUM 200	50 / 60 HZ	0.5 s	80 to 265 Vac / 110 to 375 Vdc	RS485	4	2	0	P01330833
ENERIUM 200	50 / 60 HZ	0.5 s	80 to 265 Vac / 110 to 375 Vdc	Ethernet	2	2	2	P01330834
ENERIUM 210	50 / 60 HZ	0.5 s	80 to 265 Vac / 110 to 375 Vdc	Ethernet	8	0	0	P01330835
ENERIUM 300	50 / 60 HZ	0.2 s	80 to 265 Vac / 110 to 375 Vdc	RS485	0	0	0	P01330816
ENERIUM 300	50 / 60 HZ	0.2 s	80 to 265 Vac / 110 to 375 Vdc	Ethernet	0	0	0	P01330817
ENERIUM 300	50 / 60 HZ	0.2 s	19 to 58 Vdc	RS485	0	0	0	P01330818
ENERIUM 300	50 / 60 HZ	0.2 s	19 to 58 Vdc	Ethernet	0	0	0	P01330819

Configured products

1 Model

50	ENERIUM 50 - Electrical energy - Load curves - Format 96 x 96
150	ENERIUM 50 + Trend curves - Format 96 x 96
100	ENERIUM 100 - Multi-energy - Trend curves - Format 144 x 144
110	ENERIUM 100 without display - Format 144 x 144
200	ENERIUM 100 + Load curves - Format 144 x 144
210	ENERIUM 200 without display - format 144 x 144
300	ENERIUM 200 + Power quality
310	ENERIUM 300 without display

2 Frequency of network measured

0	50 / 60 Hz
1	400 Hz (except Enerium 100 / 200 class 0.5s / 300)

3 Auxiliary power supply

0	80 to 265 Vac / 110 to 375 Vdc
1	19.2 to 58 Vdc

4 Communication

0	RS485
1	Ethernet

Attention: for choices 5, 6, 7 and 8, a maximum of 8 inputs and/or outputs is possible (ENERIUM 100-110/200-210).

Attention: for Enerium 50/150, choices 5 and 6 only allow the following combinations: 0-0, 1-1, 2-0, 0-2.

5 Metering (or on-off) inputs

0	none
1	1 input (ENERIUM 50 / 150 only)
2	2 inputs
4	4 inputs (except ENERIUM 50 / 150)
6	6 inputs (except ENERIUM 50 / 150)
8	8 inputs (except ENERIUM 50 / 150)

ENERIUM

1 2 3 4 5 6 7 8 9

6 On-off outputs

0	none
1	1 output (ENERIUM 50 / 150 only)
2	2 outputs
4	4 outputs (except ENERIUM 50 / 150)
6	6 outputs (except ENERIUM 50 / 150)
8	8 outputs (except ENERIUM 50 / 150)

7 Analog inputs (ENERIUM 100 / 200 only)

0	none
2	2 analog inputs
4	4 analog inputs
6	6 analog inputs
8	8 analog inputs

8 Analog outputs

0	none
2	2 outputs
4	4 outputs (except Enerium 50 / 150)

9 Accuracy class

5	0.5 s (except Enerium 300)
2	0.2 s (ENERIUM 200/210/300/310 only)

Example: Enerium 200, 50/60 Hz frequency, 80 to 265 Vac auxiliary power supply, RS485 communication, 2 on-off inputs, no on-off outputs, no analog inputs, no analog outputs, class 0.2 s => order ENERIUM 200 01020002 · 1-200 · 2-0 · 3-0 · 4-0 · 5-2 · 6-0 · 7-0 · 8-0 · 9-2

Accessories

Optical head for ENERIUM 50/150	P01330403
Optical head for ENERIUM 100/110 - 200/210 - 300/310	P01330401
DIN-rail mounting kit for ENERIUM 30/50/150	P01330830
DIN-rail mounting kit for ENERIUM 100/200/300	P01330360
Power supply for pour on-off inputs: 85 to 264 Vac/12 Vdc - 3.5 A (42 W)	ACCJ1004

Software

E.View	P01330601
E.View+	P01330610

FRANCE
Chauvin Arnoux Energy
 16, rue Georges Besse - Silic 44
 92182 ANTONY Cedex
 Tel: +33 1 75 60 10 30
 Fax: +33 1 46 66 62 54
 info@enerdis.fr
 www.chauvin-arnoux-energy.com/fr

UNITED KINGDOM
Chauvin Arnoux Ltd
 Nelson Ct, Flagship Sq, Shaw Cross Business Pk
 Dewsbury, West Yorkshire - WF12 7TH
 Tel: +44 1924 460 494
 Fax: +44 1924 455 328
 info@chauvin-arnoux.co.uk
 www.chauvin-arnoux.com

MIDDLE EAST
Chauvin Arnoux Middle East
 P.O. BOX 60-154
 1241 2020 JAL EL DIB - LEBANON
 Tel: +961 1 890 425
 Fax: +961 1 890 424
 camie@chauvin-arnoux.com
 www.chauvin-arnoux.com